

PROTECTING ASSETS AND SAVING LIVES

THE ECHO INDUSTRIAL FIRE PROTECTION SYSTEM

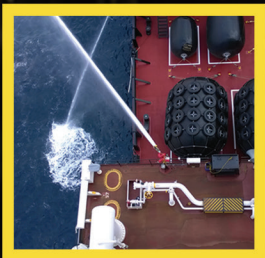

• Automated Response

• Water/Foam

• Adaptable & Scalable

WHAT IS ECHO?

ECHO is an industrial fire protection and safety system designed to operate in classified hazardous locations. The electric remote control monitor (ERCM) has been pre-engineered for a wide array of configurations and applications that include oil refineries, chemical plants, maritime use, natural gas filling stations and more.

TIMELY RESPONSE IS IMPORTANT

Response speed and accuracy in the beginning stages of a fire is the difference between a contained incident and a major rehabilitation affecting revenue generation and possible loss of lives.

ECHO SIMPLIFIES:

- System Planning
- Ordering
- Installation



AUTOMATED VS. MANUAL

SAFETY

- Earlier warning
- Faster evacuation of people

PROTECTION

- Faster action
- Automates fire suppression
- Maximizes fire suppression
 - Minimize loss of lives and assets

CONTROL

- Targets control
- Redundant coverage
- Safe operating distance

THE ECHO SYSTEM IS LOW MAINTENANCE



THE AUTOMATED ECHO SYSTEM IS PRE-ENGINEERED

PROVEN, TESTED, CERTIFIED AND GUARANTEED TO WORK TOGETHER.

SPITFIRE ELECTRIC INDUSTRIAL MONITOR

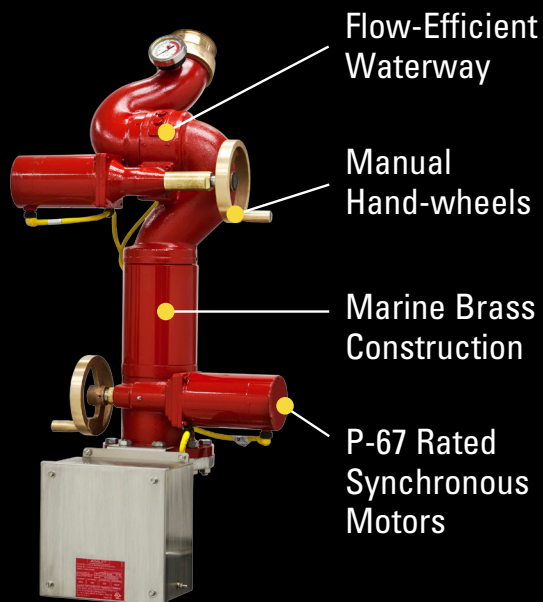

Flow-Efficient
Waterway

Manual
Hand-wheels

Marine Brass
Construction

P-67 Rated
Synchronous
Motors

X-STREAM INDUSTRIAL NOZZLES

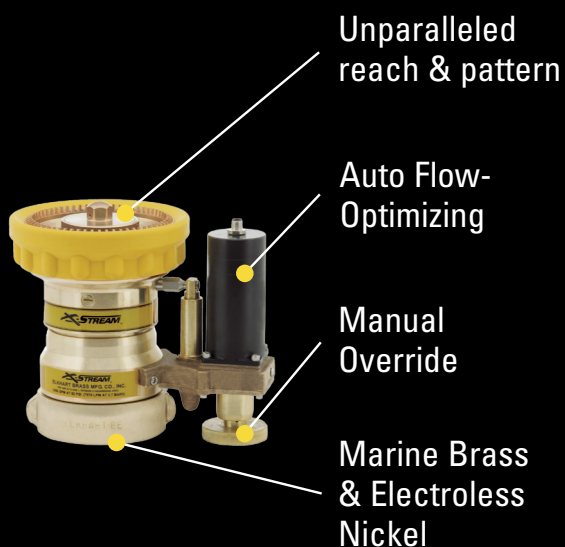

Unparalleled
reach & pattern

Auto Flow-
Optimizing

Manual
Override

Marine Brass
& Electroless
Nickel

OPERATIONAL CONTROL



ADDITIONAL ECHO SYSTEM BENEFITS:

- Components easily mix and match to create systems that exceed the site requirements
- Quick setup software
- Easily initialized and set up and ready for future expansion
- No special tools required for installation
- Reliable from -40 to +60 degree Celsius
- Available in a "Cold Weather" version, which will move at -40 without water flowing
- Lowest power requirements in industry

ATOR PANEL

Functions:

- Up/Down/Left/Right
- Fog/Stream
- Water & Foam On/Off
- Oscillate & Parks

Uses readily available components

UL Listed For:

- Outdoor Use
- Hazardous Location

Low Power Consumption
(2A @ 120VAC)

HMI GRAPHIC TOUCHSCREEN

Used in Control Rooms or other non-Hazardous Locations

Control 1-16 Monitors

Easily Interfaces to Existing Installs

Advanced Functions:

- Monitor Position
- Zoned Response



MONITOR MOTOR CONTROL PANEL

Provides Power to one monitor and has 3A power supply for valves

Rugged 316 Stainless Steel Construction

Low Power Consumption
(5A @ 120VAC)

Accepts 120/240/480VAC



CASE STUDY 1

INSTALLATION TYPE:

Refinery

LOCATION:

Western Europe

CLIENT OBJECTIVES:

- Multiple points of control
- Meet aggressive schedule
- Large facility requiring numerous points of control
- Facility turnaround project requiring aggressive installation schedule and firm budget

PROBLEM:

Process Unit requiring 8 remote-operated water cannons (monitors) with distinct controls for each and a central control required for all monitors in Command Center.

ELKHART BRASS SOLUTION:

Elkhart Brass was able to offer "Off the Shelf" ECHO system components to meet all project requirements, including regulatory requirements, budget and timing.

ELKHART BRASS ECHO SYSTEM COMPONENTS:

- 8 Spitfire Monitors and X-Stream Nozzles
- 8 Monitor Motor Control Panels
- 4 Two-Monitor Operator Control Panels
- 1 HMI Touchscreen Controller

SYSTEM OVERVIEW

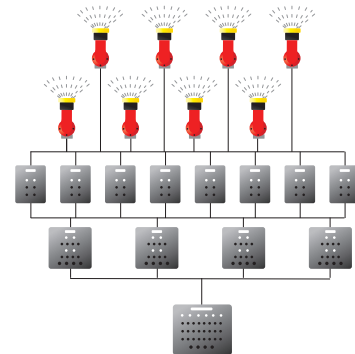

LOCAL CONTROL PANEL



CASE STUDY 2

INSTALLATION TYPE:

Refinery – Jetty

LOCATION:

Northwest U.S.A.

CLIENT OBJECTIVES:

- Provide training capability adjacent to protected waterway
- Avoid potential for accidental AFFF discharge
- Responders must be trained on fire suppression system

PROBLEM:

Needed to train crew frequently on fire protection system and exercise system components, including water flow, while protecting against accidental foam release (AFFF) into environmentally sensitive waterways.

ELKHART BRASS SOLUTION:

Solution involved specialized control programming. The customized controls provided a fire protection system with training mode that effectively blocks AFFF discharge while allowing full access to all other components of the system. The fire department can perform all necessary training exercises without harming environment or endangering wildlife.

ELKHART BRASS SYSTEM:

- 2 industrial water cannons and nozzles
- 4 foam valves
- Control system
 - 2 fixed
 - 2 portable

SYSTEM OVERVIEW

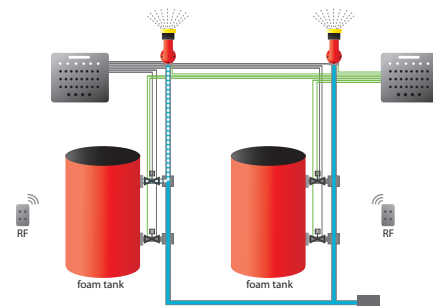

INDUSTRIAL SPIT-FIRE WATER CANNON



CASE STUDY 3

INSTALLATION TYPE:

Space Launch Facility

LOCATION:

Southwest U.S.A

CLIENT OBJECTIVES:

- System compatible with harsh desert environment
- Remote operation of fire equipment
- Control station is 3 miles away

PROBLEM:

The harsh desert environment with its extreme temperature fluctuations posed unique challenges for developing a fire protection system for this space launch facility, the system needed to operate reliably from a control room 3 miles away from the launch site.

ELKHART BRASS SOLUTION:

Elkhart's Spit-Fire water canon was an ideal match for the project. With 100% sealed motors and gearboxes, the unit can survive the extreme temperatures and dry, sandy desert environment. The Spit-Fire, when coupled with Elkhart's X-Stream series nozzles, delivers maximum reach with a controllable pattern. The entire system is connected via fiber optics to the distant control station.

ELKHART BRASS SYSTEM:

- 2 Industrial water cannons and nozzles
- 3 Industrial valves
- 2 Control stations
 - 1 Master, linked via fiber optics
 - 1 local, hardwired
- Remote valve control interface

SYSTEM OVERVIEW

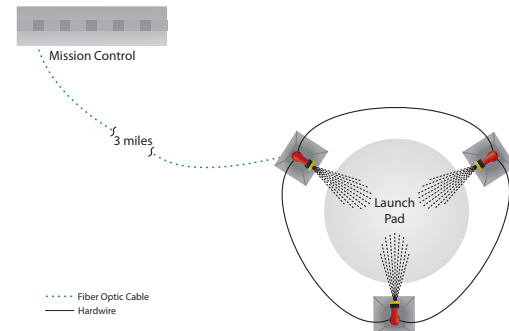

X-STREAM® NOZZLE



INDUSTRIAL SPIT-FIRE WATER CANNON

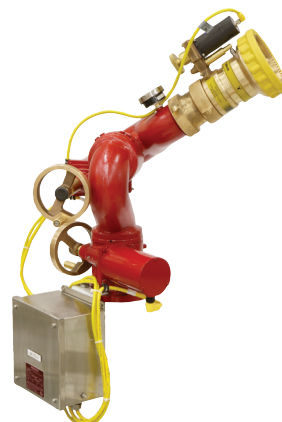

**TO LEARN MORE ABOUT THE SYSTEM,
PLEASE VISIT: WWW.ELKHARTBRASS.COM**



**800-346-0250 • 1-574-295-8330
1302 West Beardsley Ave. • Elkhart, IN 46514**